



# **CLEVER CLICK RIGID**

## XL Tile and Plank Installation Guide

---

Revolutionary, quick and easy flooring with the natural beauty of wood and stone

# How to Install Clever Click Rigid

A Clever Click Rigid vinyl floor will transform your home and bring you years of pleasure.

---

## To assist you, we have created this concise step-by-step guide.

However, to make the most of Clever Click Rigid flooring, you must understand how to install the product properly. If you do not install your floor properly, the guarantee will be void.

## Before you start

- Do not store directly on concrete, allow for air circulation. Do not open the cartons but spread them out and protect corners from damage.
- Before installation, planks / tiles must be allowed to accimatise to the room conditions. For that purpose, the original packages shall be horizontally stored unopened in groups of 4-5 for at least 48 hours in the room with normal temperature conditions. Make sure that temperature in the room of installation lies between 18°C and 25°C. Relative humidity should lie between 40%-65% (minimum and maximum values, respectively). Both limit values must also be maintained during installation and afterwards, in the course of regular living use. Subfloor temperature must be at least 15°C. To avoid damage to the product, handle packages carefully and open them just prior to installation.
- Slight variations in colour and structure are designed to enhance natural appearance. Mixing the planks or tile during installation creates a more visually pattern.
- Avoid exposure to direct sunlight for prolonged periods. If this happens it may impact the flooring locking system and may result in discolouration. Please contact your supplier for additional information.
- Inspect all planks or tiles for damage before installing. Claim will not be accepted for flooring that has been cut to size and/or install.
- Load limits and high point loads should be considered as not to restrict floor from floating.

---

## The subfloor

- Proper preparation of the subfloor is a major part of a successful installation. Roughness or unevenness of the subfloor may telegraph through the new flooring. All subfloors should be smooth and dust free with a flatness tolerance not exceeding more than  $\frac{1}{8}$ " in a 10' span. Cracks and holes must be filled with fast setting cement-based polymer modified patching compound or equivalent.
- Any unevenness over  $\frac{3}{16}$ " (4.7mm) must be sanded down or levelled. The surface must be clean of dirt, oil, glue residue etc. Carpet staples or adhesive residue should be removed prior to installation. Voids or humps in the subfloor will prevent the planks from locking properly.
- Although these SPC click planks or tiles are water resistant, they are not to be used as a moisture barrier. Your subfloor should be completely dry prior to installation of the SPC floor. SPC floors do not warrant nor is responsible for damage to floor covering due to moisture related issues.
- The subfloor must be constructed properly - clean, sound and flat. Any bumps caused by paint or plaster drops etc. must be removed.
- SPC click planks or tiles can be installed on existing firm floors (Linoleum, PVC), but a textile floor must be removed. When laying the floor on tiles, fill the gaps with grout or patch to make the surface smooth.
- SPC click planks or tiles are already quiet to walk on. Additional noise reduction is only possible using specialised materials.

# How to Install Clever Click Rigid

## Installation

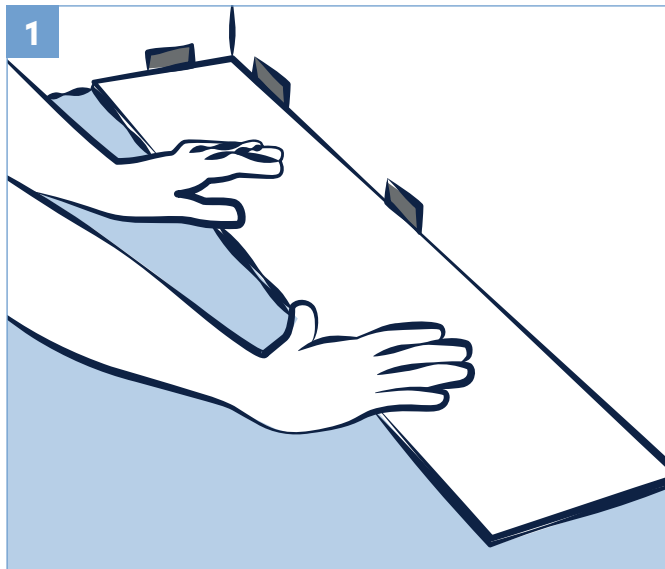

1  
Begin laying planks/tiles from the left side of the starting wall and work to the right side. The tongue of the plank should face the starting wall. Place 1/4" (6.35 mm) spacers between the short and long side of the planks/tiles and the wall. Always position one spacer between the wall and where the planks/tiles join.

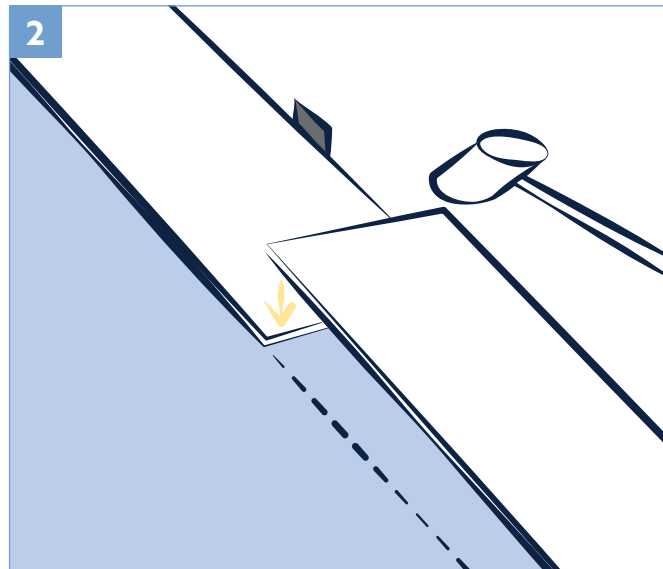

2  
The end joints of the planks/tiles in the first row are assembled by inserting the tongue side into the groove side of the previous plank/tile at a low angle. Gradually lower the plank/tile down flat until the end joint closes, ensuring that the planks/tiles are perfectly aligned. Install remaining full planks/tiles in the first row.

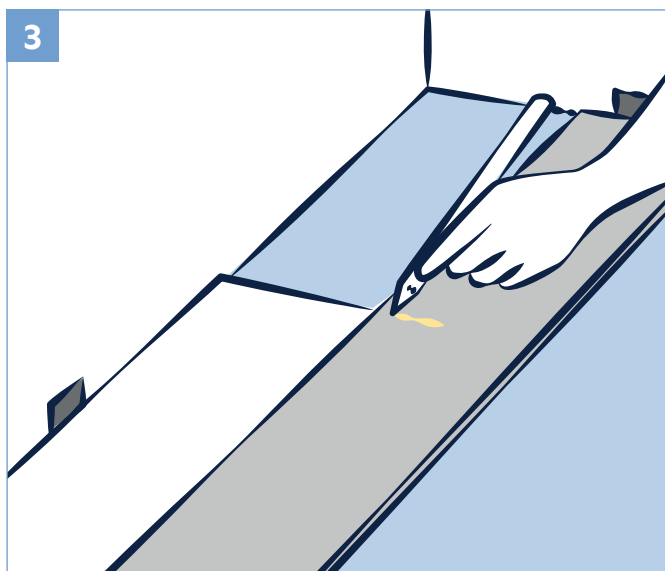

3  
Continue connecting the first row until you reach the last full plank. Fit the last plank by rotating the plank 180° with the pattern side upward, place beside row. Measure and mark, then using a ruler and utility knife, score the plank and snap off. Attach as described above.

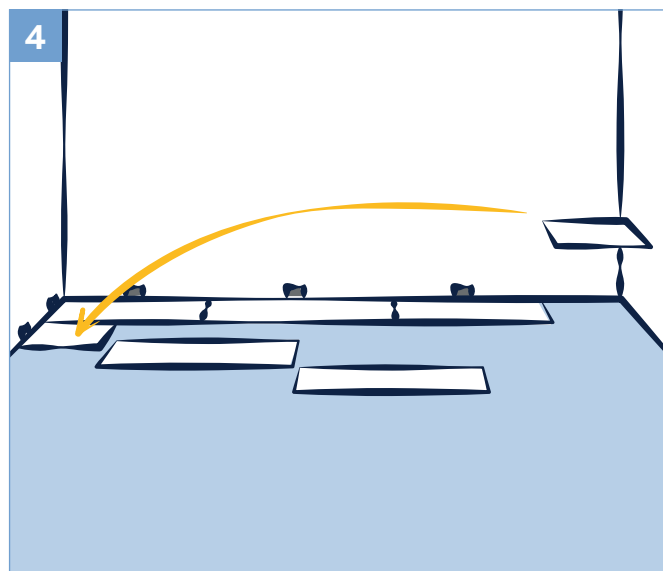

4  
The remaining piece cut off from the last plank/tile in the first row may serve as the first plank/tile in the second row provided it is at least 8" (20 cm) long. Always stagger end joints from row to row a minimum of 8" (20 cm) apart.

## Note

To fully engage the end joints to the previous panel a rubber mallet may be used to ensure it completely locks in place.

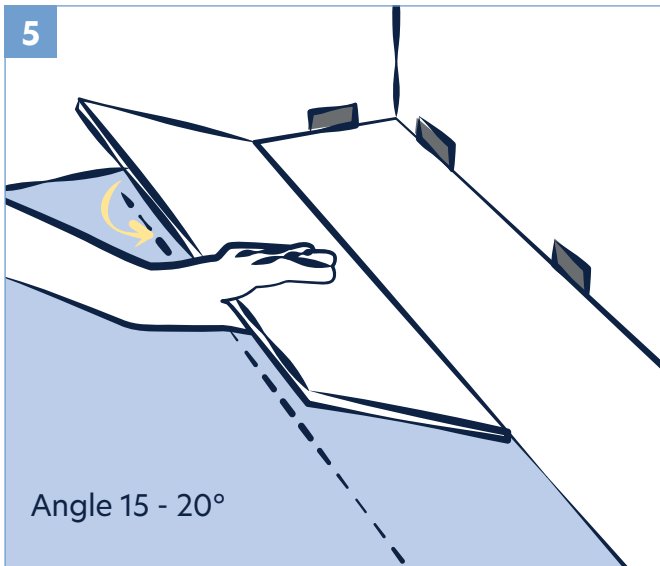

Install the long side of the first plank/tile of the second row. Place a 1/4" (6.35 mm) spacer between the wall and the short side of the plank/tile. Insert the tongue side into the groove side of the plank/ tile from the previous row at a low angle and lower flat to the substrate.

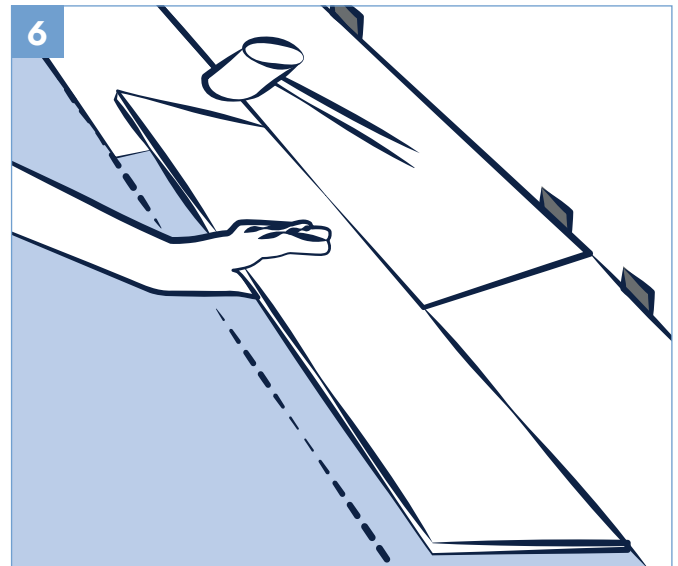

Install the second plank/tile of the second row. Position the long side of the plank/tile with the tongue side, fully engage into the receiver of the first row of product. Lower the plank/ tile with firm pressure to the floor, ensuring that the end joint is overlapping and perfectly aligned; push the end joint downward till the end of the plank/tile snaps in place.

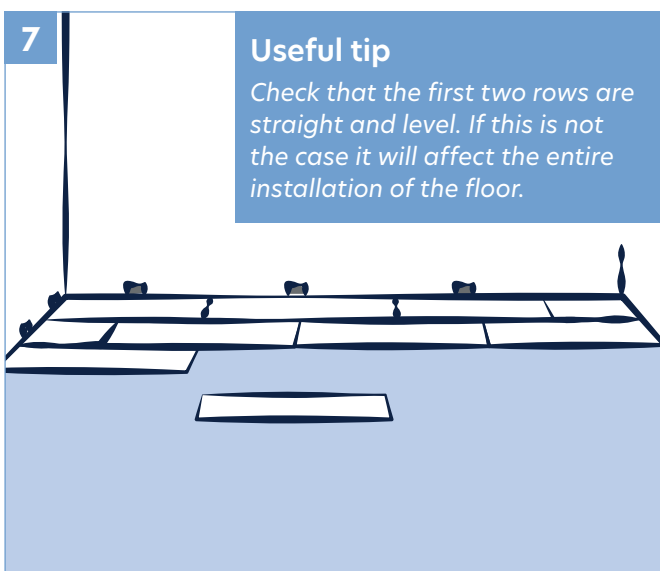

Continue installing planks/tiles in the second row. Continue working from left to right, row by row. Be sure to maintain a 1/4" (6.35 mm) space around all walls and vertical objects. To maintain a random appearance, remember to offset end joints a minimum of 8" (20cm).



Transition mouldings are required every 65 feet (19.18 m) in any direction and at all doorways.

# How to Install Clever Click Rigid

---

## Care and maintenance

- Do not wax or polish your SPC click flooring.
- For everyday cleaning, use a vacuum cleaner with wand attachment, a sweeping broom or a slightly dampened mop.
- Do not clean your floor with abrasive cleaners, abrasive scrubbing pads or scouring powdered products.
- Appropriate mats at entryways are recommended to collect tracked-in dirt, sand and pebbles.
- Frequently moved furniture should be equipped with felt pads to avoid scratching the floor. Heavy furniture and appliances should be equipped with non-staining large surface floor protectors. Furniture with castors or wheels must be easy swiveling, large surface non-staining and suitable for resilient floors.
- Care must be required whenever furniture is moved, furnished should never be dragged across the floor. Use appropriate moving pads if necessary.





# CLEVER CLICK RIGID

Whilst Guardian has made every attempt to ensure that this information is accurate and reliable at the time of its publication; we cannot accept responsibility for any errors, omissions, inaccuracies or any changes that have occurred since the date of publication or for the results obtained from the use of such information.

Version 1 | November 2024